

# STOP

DO NOT INSTALL UNTIL YOU HAVE READ THESE GUIDELINES

Call Client Services at 1.773.465.6909 immediately if you encounter any difficulties or e-mail [clientservices@mayaromanoff.com](mailto:clientservices@mayaromanoff.com)

GUIDELINES FOR INSTALLATION ON DRYWALL.\* Materials may display certain irregularities that are inherent to the manufacturing process.

## Stitched Vertical™

(MR-SV Series) Hand-Painted Paper With Thread *David Rockwell for Maya Romanoff*



### SPECIFICATIONS

Width Approx. 30" untrimmed (76.2 cm), 7.5 sq ft/yd (0.7 sq m/yd)

Roll Size 3 yd (2.7 m)

Minimum Order 24 yd (21.9 m)

Order Increments 3 yd (2.7 m)

Repeat Approx. 29" W (73.7 cm)

Custom Color/Length 24 yd min. order (21.9 m)

Fire Rating ASTM E84 Class A

Content Hand-painted paper, Thread

### RECOMMENDED TOOLS

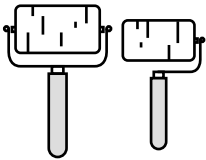

Seam roller & corner seam roller

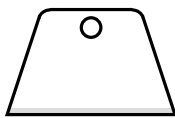

Plastic smoother

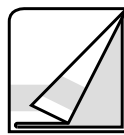

Soft cloth

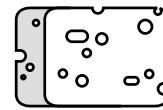

Sponge



Clean water

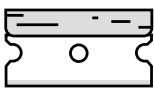

Razor blades

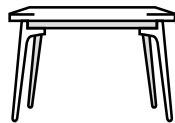

Table

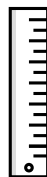

Steel straight edge

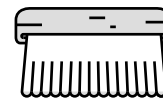

Soft-bristled nylon brush

### WALL PREPARATION

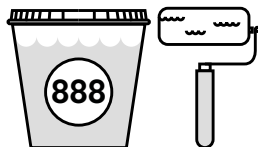

Maya Romanoff Heavy-Duty Clear Adhesive MR-RA-888 or comparable & 1/2" nap roller



Roman Pro-977 Ultra Prime Primer or comparable

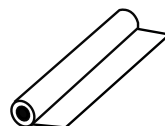

Heavy-Duty Wall Liner Available from Maya Romanoff

\*Consult Client Services before you begin application on surfaces other than drywall.

02.16.2024

1

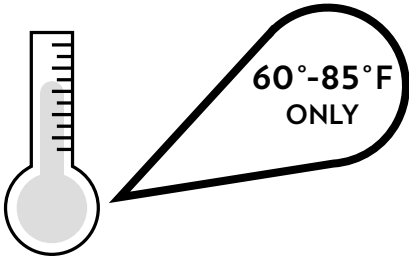
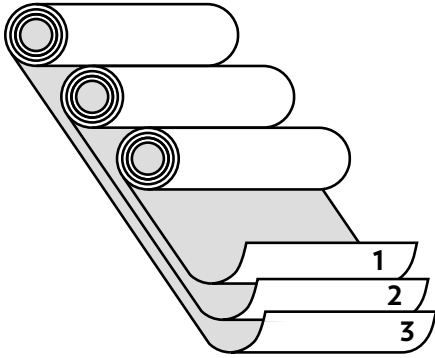

## GENERAL GUIDELINES

Product has been pre-graded from left to right and labeled accordingly on the back. **You must still grade for color flow within your installation.**

---

Inspect goods carefully.

---

Confirm you have the correct quantity and color of product before installing. Additional yardage from this dye lot may not be available.

---

No allowances will be made after three (3) drops are installed. No returns on cut goods.

---

No claims allowed for labor charges or consequential damages, under any conditions.

---

No claims allowed if lighting in area where product is hung is not finished/fully installed.

---

Product is not guaranteed against fading or color change.

---

Store uninstalled material between 60° - 85°F in a dry place.

---

Wallcovering **MUST** be installed in a climate controlled environment with an approximate constant temperature of 70°F and a relative humidity level of 50-55%.

2

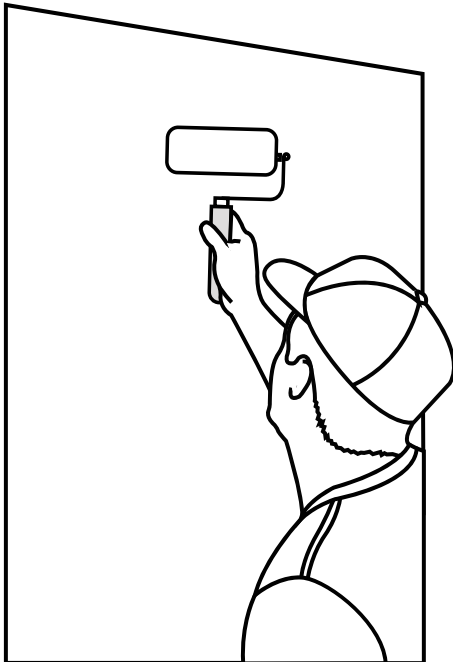

## WALL PREPARATION

Prior to installation on drywall, paint the walls with Roman Pro-977 Ultra Prime Primer or comparable tinted close to the color of your product.

---

Do not use sealing primer/do not install on sealed walls (no eggshell, satin or semi-gloss paints).

---

Walls should be smooth and sanded. If walls are already sealed or have imperfections, consider hanging heavy-duty non-woven wall liner (available from Maya Romanoff) prior to installing the product. This is at the discretion of your installer.

---

Walls must be completely dry before installation can begin.

3

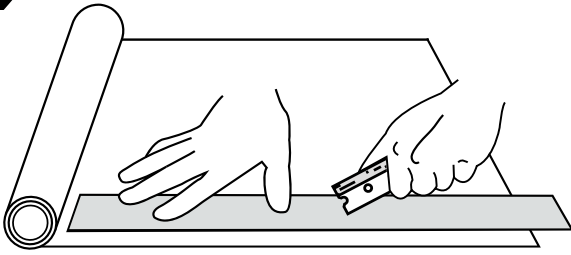

## TRIMMING

Table-trim 1/4" off left edge and 3/4" off right edge so that there are 1.5" between the stitched lines at the seam. See diagram, Section 7, for pattern match.

Use a very sharp, single-edge razor blade. Use a new razor blade for each cut.

4

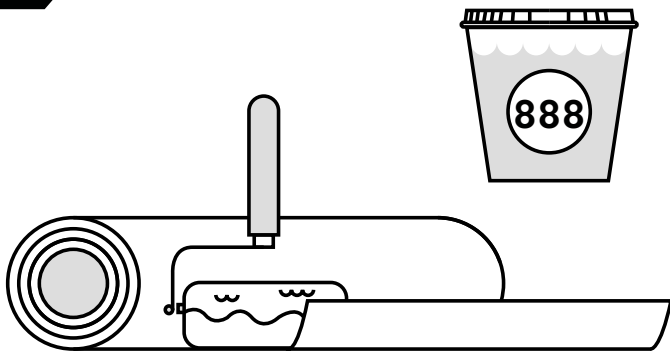

## PASTING

Before pasting paper, slightly wet back side of paper with sponge and let paper relax 2-4 minutes.

Use Maya Romanoff Heavy-Duty Clear Adhesive MR-RA-888 or comparable.

Pasting before trimming is preferred.

Apply a generous, even coat of adhesive to backside of product and let relax.

Allow wallcovering to relax until adhesive tacks up. Perform a test on a small strip to determine appropriate relaxing time. **See reference chart on the left.**

Allow the paste to soak into each sheet for the appropriate time before hanging in order to avoid paper bubbling, expansion, shrinking and seam opening.

Do not fold or crease the wallcovering.

Do not get paste on the face of the product. **If paste gets on the face of the product, do not scrub nor rub.** Instead, immediately gently wipe clean with a soft, damp cloth. Do not use paper towel on the product.

Paper expansion is NORMAL. Paper may expand up to 3/4" – relaxing time is critical.

### RELAXING TIME

5-7 min  
WHITE PAPER

MR-SV-58-X15-O  
MR-SV-58-055-S

18-22 min\*  
BROWN PAPER

MR-SV-36-244-L

\*Allow 9-11 min, then open up, repaste and allow an additional 9-11 min.

5



## HANGING

All patterns are directional. Rolls are marked “TOP.” No side-match. Do not reverse hang.

Apply product to the wall using a soft-bristled nylon brush. **Do not use a stiff brush.**

Gently smooth product with a plastic smoother to remove bubbles.

A seam roller may be used to set seams. Please take proper precaution.

Go back and ensure all bubbles are smoothed out before leaving. Any bubbles left upon completion of install will be permanent

The color of the product may bleed onto the wall while hanging. **This is normal and will not affect the final installation.**

This product is handmade. Slight color and/or pattern match variation may occur.

6

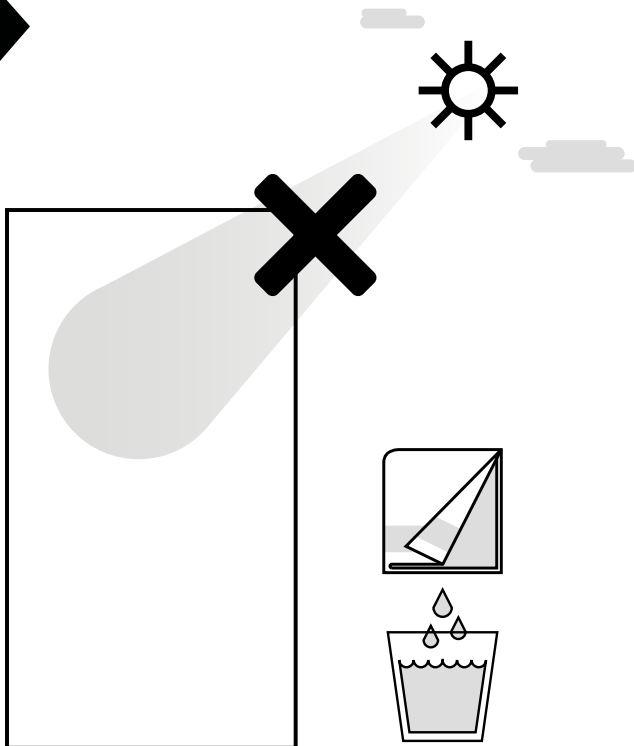

## CARE & CLEANING

Avoid direct or reflected sunlight. Our wallcoverings are not guaranteed against fading or color change.

Maya Romanoff wallcoverings are formulated for dry-use areas.

Before cleaning any wallcoverings, test first on a small, inconspicuous area.

Avoid getting the wallcovering excessively wet.

Never use abrasive cleansers or steel wool as they will mar the surface.

Clean by blotting the soiled area with a soft, clean cloth, dampened with a mild solution of clear liquid detergent. Dry with a soft, clean cloth.

Do not use harsh cleaners, solvents, or chemicals of any kind to clean Maya Romanoff products unless following the guidelines outlined in our Care, Cleaning and Disinfecting document, available at [MayaRomanoffDropbox.com](https://www.mayaromanoff.com/dropbox). When used as directed, disinfectant wipes and diluted bleach/water solutions can be safe and effective sanitization methods for the majority of our wallcoverings.

# 7

## TRIMMING DIAGRAM

PATTERN REPEAT: 29"W

**Measure 1/4" from LEFT edge and trim.  
Measure 3/4" from RIGHT edge and trim.**

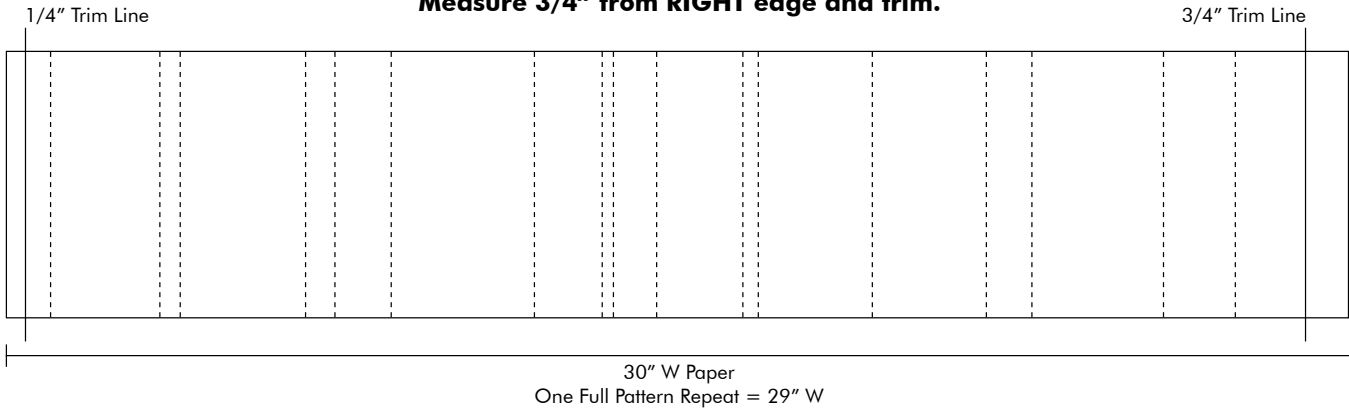

**After installing two drops, check to make sure that  
there is 1-1/2" from stitch line to stitch line across seam.**

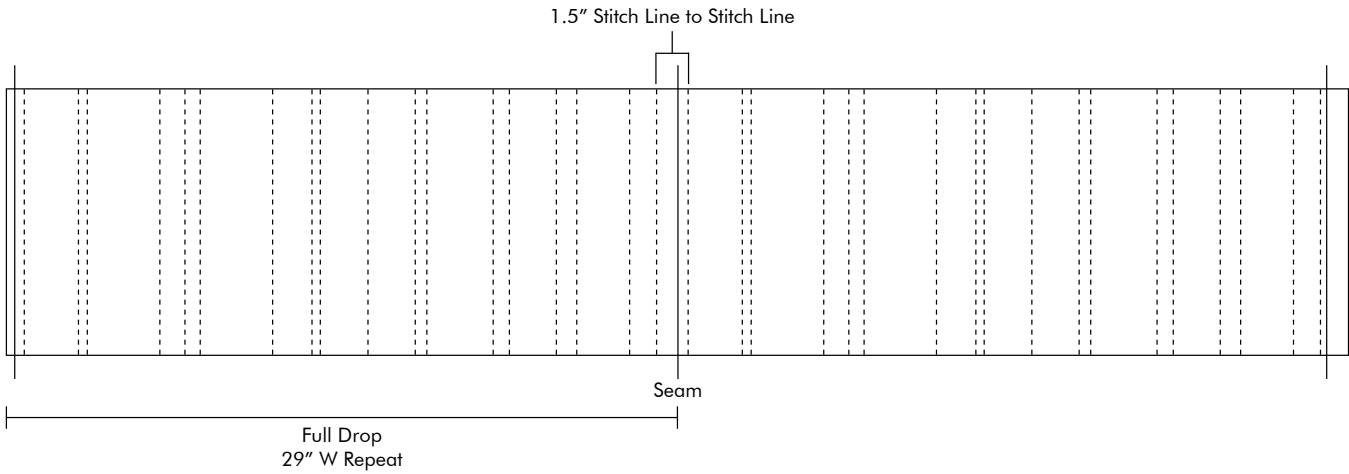

**Two Full Drops Shown**



MAYA ROMANOFF