

STOP

DO NOT INSTALL UNTIL YOU HAVE READ THESE GUIDELINES

Call Client Services at 1.773.465.6909 immediately if you encounter any difficulties or e-mail clientservices@mayaromanoff.com

GUIDELINES FOR INSTALLATION ON DRYWALL.* Materials may display certain irregularities that are inherent to the manufacturing process.

Ajiro Coffers™

(MR-AD1 & MR-AD2 Series) Hand Inlaid Wood Veneer



SPECIFICATIONS

AD1: Ajiro Coffers

Width Approx. 36" untrimmed (91.4 cm), Repeat Approx. 9" W x 10" H

Roll Size 21 yd (19.2 m), Order Increments 7 yd (6.4 m)

Minimum Order 21 yd (19.2 m), Minimum Order AD1-3604 14 yd (12.8 m)

Custom Color 21 yd min. order (19.2 m)

Fire Rating ASTM E84 Class A, EN 13501 Euroclass B

Content Natural wood veneer, Non-woven paper backing

AD2: Grand Scale Ajiro Coffers

Width 30" untrimmed (76.2 cm), Panel Repeat 30"W x 18"H (76.2 cm x 45.7 cm); Square Repeat 15"W x 18"H (38.1 cm x 45.7 cm)

Roll Size 3.5 yd (3.2 m), Order Increments 1 roll (3.5 yd/3.2 m)

Minimum Order 8 rolls (28 yd/25.6 m), Minimum Order AD2-4604 4 rolls 14 yd/12.8m)

Custom Color 8 rolls (28 yd/25.6 m)

Fire Rating ASTM E84 Class A, EN 13501 Euroclass B

Content Natural wood veneer, Non-woven paper backing

RECOMMENDED TOOLS



Clean water

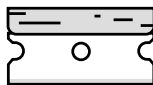

Razor Blades

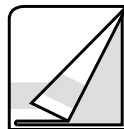

Soft cloth

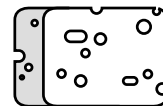

Sponge

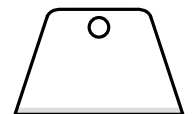

Plastic smoother

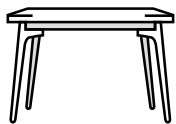

Table



Double cutting tool

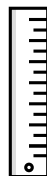

Steel straight edge

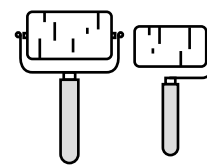

Seam roller & corner seam roller

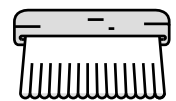

Soft-bristled nylon brush

WALL PREPARATION



Maya Romanoff Heavy-Duty Clear Adhesive MR-RA-838 or comparable & 1/2" nap roller



Roman Pro-977 Ultra Prime Primer or comparable

*Consult Client Services before you begin application on surfaces other than drywall.

03.27.2025

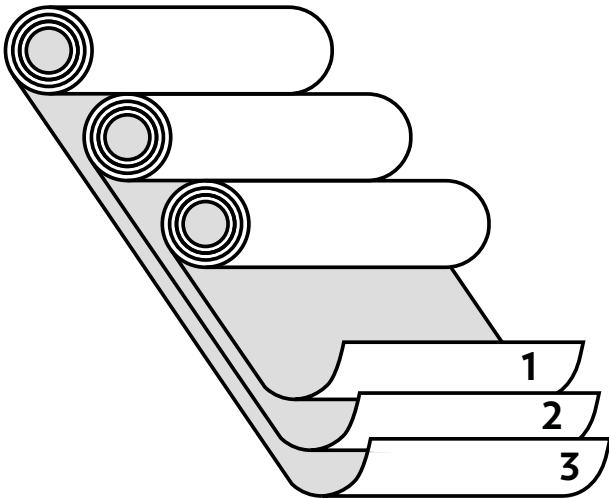
1

60-85°F^F
ONLY

GENERAL GUIDELINES

Product has been pre-graded from left to right and labeled accordingly on the back. **You must still grade for color flow within your installation.**

Inspect goods carefully.

Confirm you have the correct quantity and color of product before installing. Additional yardage from this dye lot may not be available.

No allowances will be made after three (3) drops are installed. No returns on cut goods.

No claims allowed for labor charges or consequential damages, under any conditions.

No claims allowed if lighting in area where product is hung is not finished/fully installed.

Product is not guaranteed against fading or color change.

Store uninstalled material between 60° - 85°F in a dry place.

Wallcovering **MUST** be installed in a climate controlled environment with an approximate constant temperature of 70°F and a relative humidity level of 50-55%.

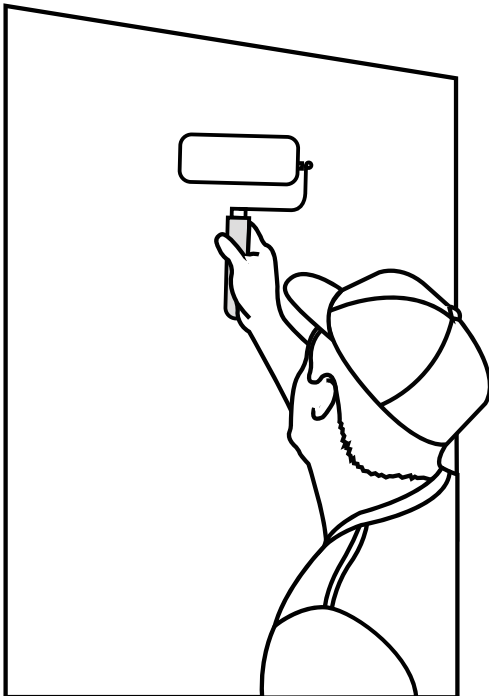
2

WALL PREPARATION

Prior to installation on drywall, paint the walls with Roman Pro-977 Ultra Prime Primer or comparable tinted close to the color of your product.

Do not use sealing primer/do not install on sealed walls (no eggshell, satin or semi-gloss paints).

Walls should be smooth and sanded. If walls are already sealed or have imperfections, consider hanging heavy-duty non-woven wall liner (available from Maya Romanoff) prior to installing the product. This is at the discretion of your installer.

Walls must be completely dry before installation can begin.

3

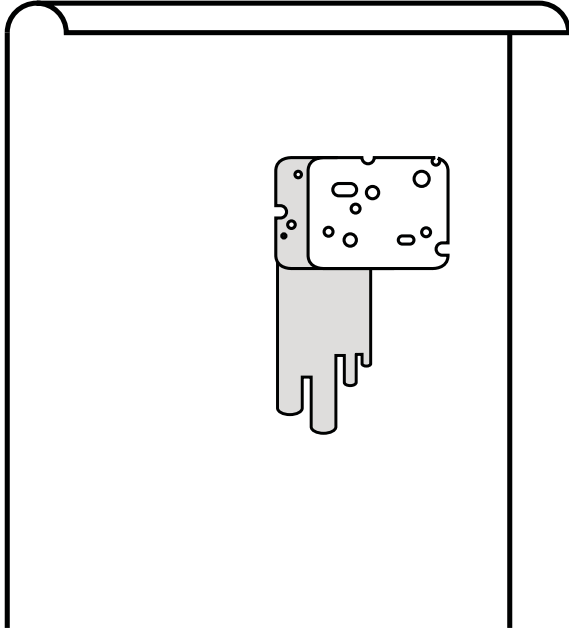

PAPER PREPARATION

Before pasting backside of paper, dampen the face and back of this product with a wet sponge. Do NOT soak. The purpose is to relax and flatten the product.

Let relax for 15-20 minutes.

Repeat relaxing process until the product lies flat.

4

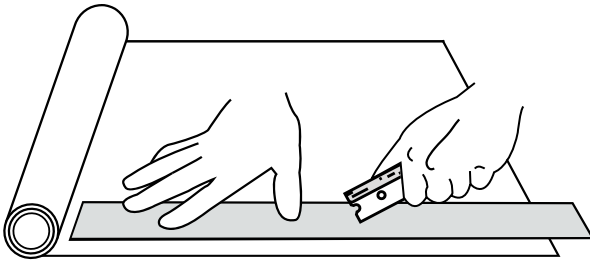

OR

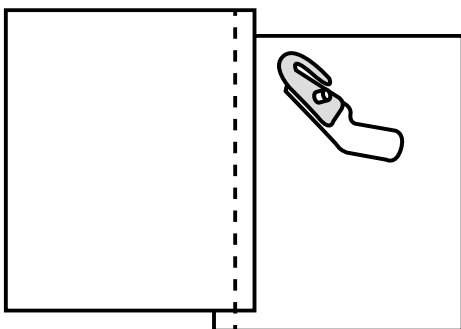

TRIMMING

Trim product after relaxing.

Factory edge is NOT suitable for seaming. This product MUST be trimmed on the table OR double-cut on the wall. Double-cut using a tool such as an Advance Steam Buster to avoid cutting into the wall surface.

Use a very sharp, single-edge razor blade. Use a new razor blade for each cut.

Due to the handmade nature of Ajiro, there may be slight variation in the width of the roll. Trim a small amount to minimally affect the pattern repeat.

5



5-7
MINS

PASTING

Use Maya Romanoff Heavy Duty Clear Adhesive MR-RA-838 or comparable.

Apply a generous, even coat of adhesive to backside of product and let relax.

Typical relaxing time is 5-7 minutes until adhesive tacks up. Perform a test on a small strip to determine appropriate relaxing time.

Allow the paste to soak into each sheet for the appropriate time before hanging in order to avoid bubbling, shrinking & seam opening.

Do not fold or crease the wallcovering.

Do not get paste on the face of the product. **If paste gets on the face of the product, do not scrub nor rub.** Instead, immediately gently wipe clean with a soft, damp cloth. Do not use paper towel on the product.

6

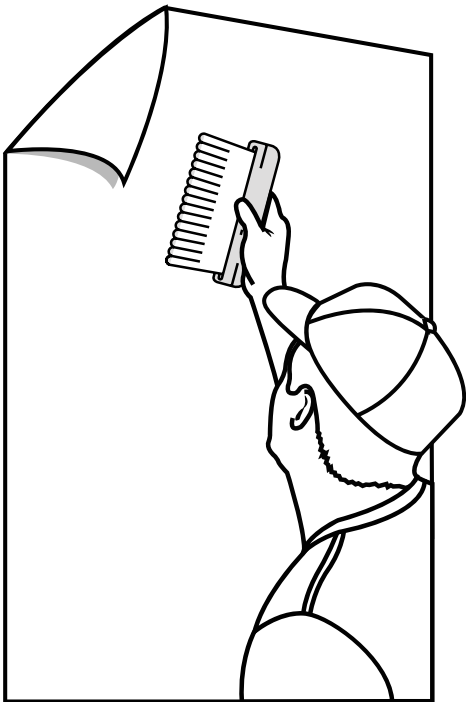

HANGING

All patterns are directional. (Rolls are marked "TOP" for AD2) No side-match. Do not reverse hang.

Apply product to the wall using a soft-bristled nylon brush

DO NOT USE A STIFF BRUSH.

Gently smooth product with a plastic smoother to remove bubbles.

A seam roller may be used to set seams. Please take proper precaution.

Use a corner seam roller to ease the material into moldings, casework, etc. prior to cutting the top or bottom of product.

This product is handmade. Slight color and/or pattern match variation may occur.

7

REPAIRING EDGES OF INLAY

Product must be completely dry before repairing.

Edges of inlay pattern may lift from the paper during or after installation. Lifted edges can be repaired by applying heat to the area. Apply pressure with an iron on a warm setting. Keep a clean piece of white cloth between the iron and the face of the product.

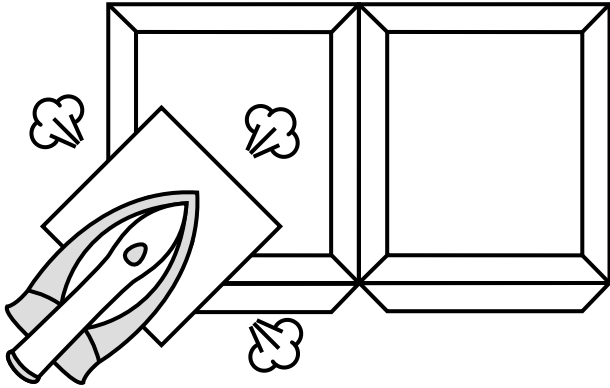

DO NOT PLACE IRON DIRECTLY ONTO THE FACE OF THE PRODUCT.

8

WRAPPING OUTSIDE CORNERS

Be sure corners are smooth and square before beginning.

Pre-paste the area to be wrapped with Maya Romanoff Adhesive MR-RA-838 prior to installation and **let it dry**.

The section to be wrapped should have as large of a portion of the inlay motif as possible on each side of the corner.

Before pasting backside of paper, dampen the face and back of the product with a wet sponge. Do not soak. Allow to relax.

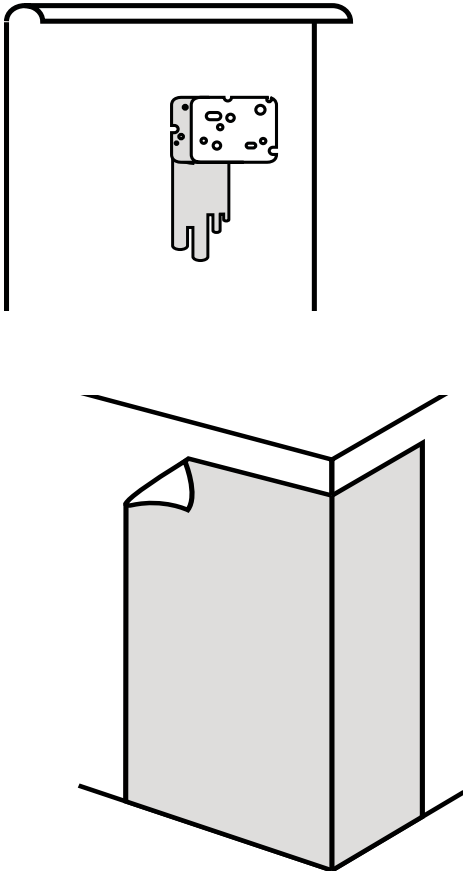

9

IMPORTANT: Applying any coatings to MAYA ROMANOFF wallcoverings outside of MAYA ROMANOFF's manufacturing facilities will void all product warranties.

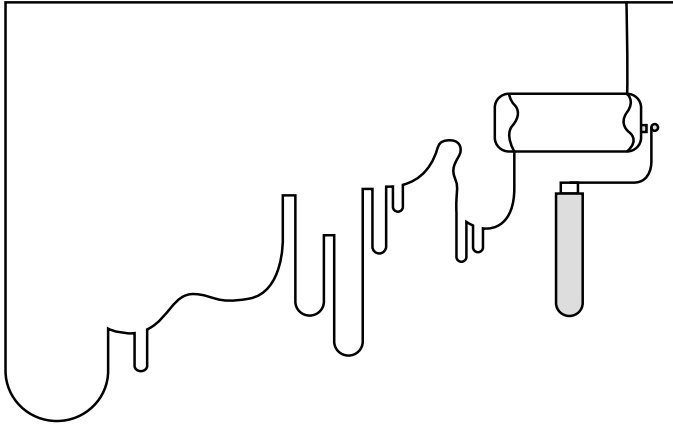

ADDITIONAL PROTECTIVE COATING APPLICATION GUIDELINES

A thin layer of water-based polyurethane may be applied to the installed wallcovering 48 hours after product installation (wallcovering adhesive must be dry). This will form a barrier coat and help prevent moisture from penetrating the wood inlay.

We recommend Benjamin Moore Stays Clear® Polyurethane or a good quality, water-based acrylic polyurethane. Different finishes are available.

Perform a test on scrap material before applying to the installed surface.

Apply a generous coat to installed product with a foam or nap roller.

Smooth polyurethane with a 4" foam brush.

After smoothing once, go back over the area several times before it is dry, with a softer touch each time. This allows for even polyurethane application and catches any drips.

If extra protection is desired, re-apply a second coat after another 48 hours of curing.

Consult the polyurethane manufacturer's application guidelines. Maya Romanoff is not responsible for unsatisfactory results.

Maya Romanoff wallcoverings are primarily formulated for dry-use areas. The above guidelines are not a guarantee of waterproofing.

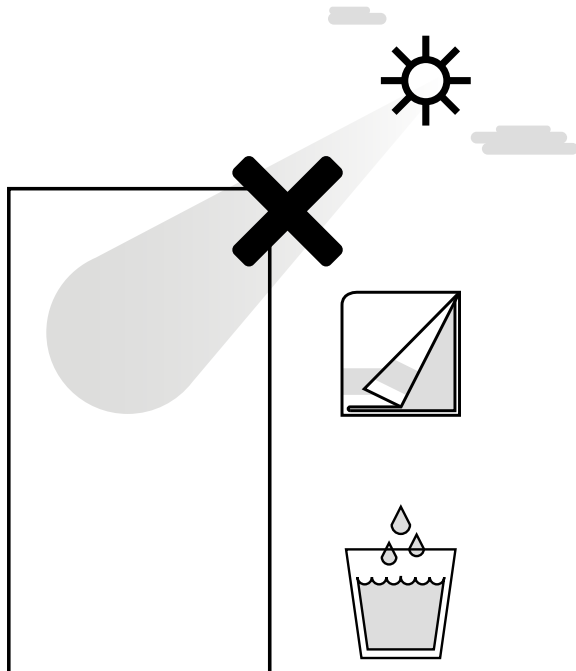
10

CARE & CLEANING

Avoid direct or reflected sunlight. Our wallcoverings are not guaranteed against fading or color change.

Maya Romanoff wallcoverings are formulated for dry-use areas.

Before cleaning any wallcoverings, test first on a small, inconspicuous area.

Avoid getting the wallcovering excessively wet.

Never use abrasive cleansers or steel wool as they will mar the surface.

Clean by blotting the soiled area with a soft, clean cloth, dampened with a mild solution of clear liquid detergent. Dry with a soft, clean cloth.

Do not use harsh cleaners, solvents, or chemicals of any kind to clean Maya Romanoff products unless following the guidelines outlined in our Care, Cleaning and Disinfecting document, available at [MayaRomanoffDropbox.com](https://www.mayaromanoff.com/MayaRomanoffDropbox.com). When used as directed, disinfectant wipes and diluted bleach/water solutions can be safe and effective sanitization methods for the majority of our wallcoverings.

INSTALLATION DIAGRAM: AD1 SERIES

ALTERNATE GRAIN DIRECTION

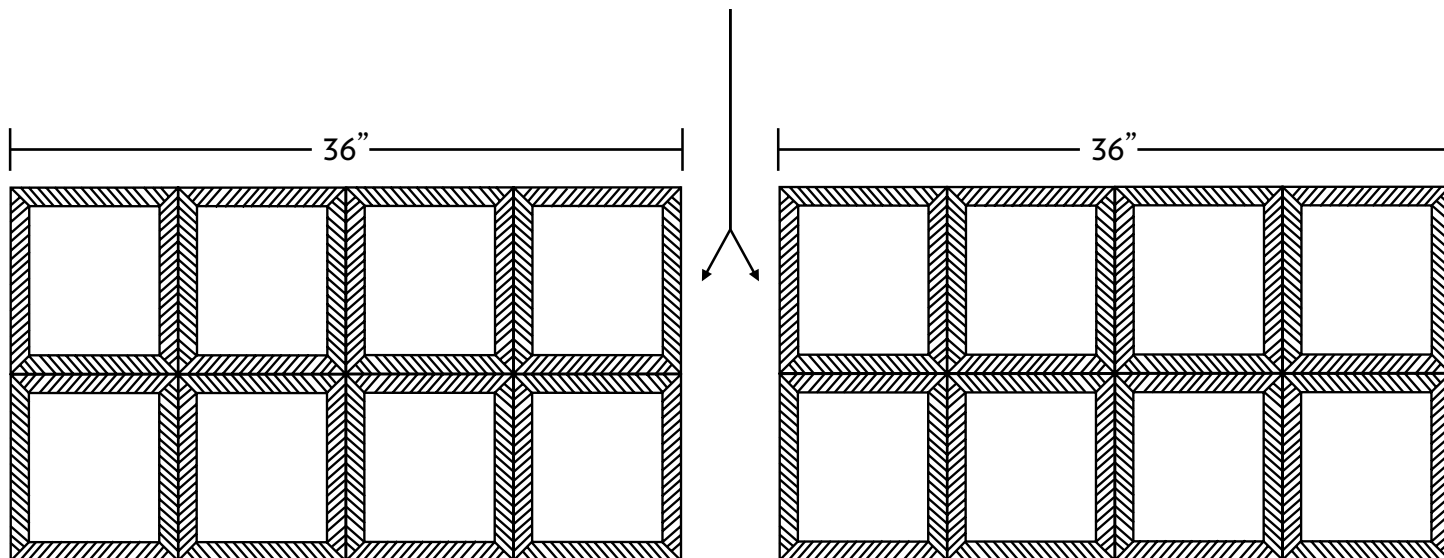

INSTALLATION DIAGRAM: AD2 SERIES

ALTERNATE GRAIN DIRECTION

