

# STOP

DO NOT INSTALL UNTIL YOU HAVE READ THESE GUIDELINES

Call Client Services at 1.773.465.6909 immediately if you encounter any difficulties or e-mail [clientservices@mayaromanoff.com](mailto:clientservices@mayaromanoff.com)

**GUIDELINES FOR INSTALLATION ON DRYWALL.\*** This is a handmade wallcovering. Materials may display certain irregularities that are inherent to the manufacturing process.

## Serigraph Brocade™

(MR-SPB SERIES) Screen Printed in Chicago



### SPECIFICATIONS

Width 36.5" untrimmed (92.7 cm), 36" trimmed (91.4 cm), 9 sq ft/yd (0.8 sq m/yd)

Roll Size 3.2 yd (2.9 m)

Minimum Order 4 rolls (12.7 yd/11.6 m)

Order Increments 1 roll (3.2 yd/2.9 m)

Repeat 36" W x 36.1" H (91.4 x 91.7 cm)

Custom Color/Length Contact Client Services

Fire Rating ASTM E84 Class A

Content FSC-sourced non-woven paper, No-VOC ink

### RECOMMENDED TOOLS



Clean water

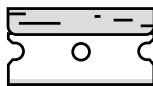

Razor Blades

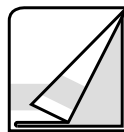

Soft cloth

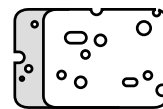

Sponge

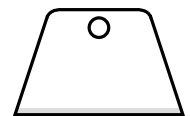

Plastic smoother

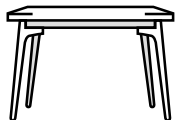

Table

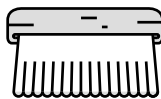

Soft-bristled nylon brush



Steel straight edge

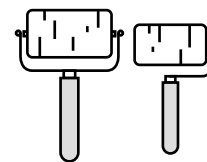

Seam roller &  
corner seam roller

### WALL PREPARATION

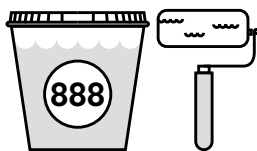

Maya Romanoff Clear Strippable  
Adhesive MR-RA-888  
or comparable & 1/2" nap roller



Roman Pro-977 Ultra Prime Primer  
or comparable

\*Consult Client Services before you begin application on surfaces other than drywall.

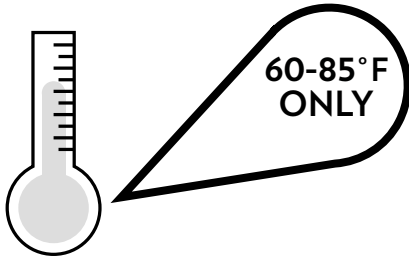
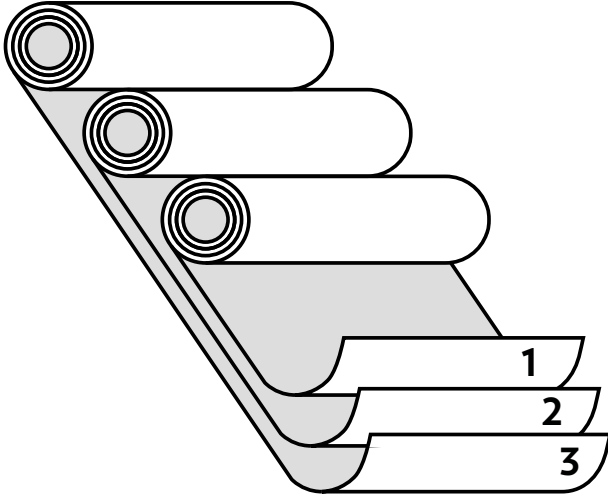
**1**

## GENERAL GUIDELINES

Product has been pre-graded from left to right and labeled accordingly on the back. **You must still grade for color flow within your installation.**

---

Inspect goods carefully.

---

Confirm you have the correct quantity and color of product before installing. Additional yardage from this dye lot may not be available.

---

No allowances will be made after three (3) drops are installed. No returns on cut goods.

---

No claims allowed for labor charges or consequential damages, under any conditions.

---

No claims allowed if lighting in area where product is hung is not finished/fully installed.

---

Product is not guaranteed against fading or color change.

---

Store material between 60° - 85°F in a dry place.

---

Wallcoverings must be installed in a climate controlled environment with an approximate, consistent, temperature of 70°F and relative humidity level of 50-55%

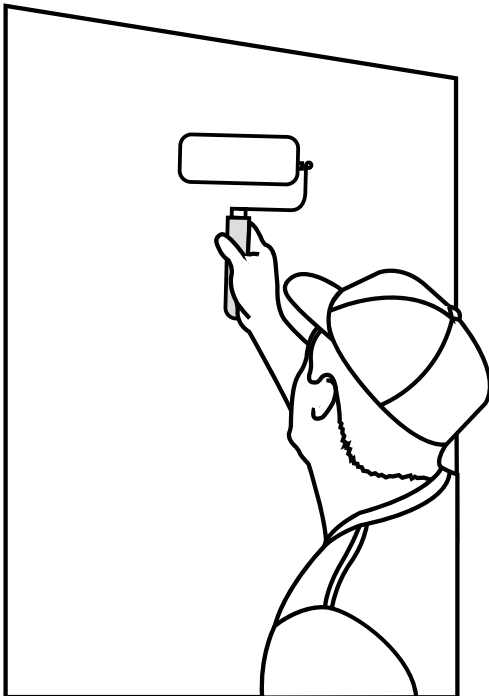
**2**

## WALL PREPARATION

Prior to installation on drywall, paint the walls with Roman Pro-977 Ultra Prime Primer or comparable tinted close to the color of your product.

---

Do not use sealing primer/do not install on sealed walls (no eggshell, satin or semi-gloss paints).

---

Walls should be smooth and sanded. If walls are already sealed or have imperfections, consider hanging heavy-duty non-woven wall liner (available from Maya Romanoff) prior to installing the product. This is at the discretion of your installer.

---

Walls must be completely dry before installation can begin.

3

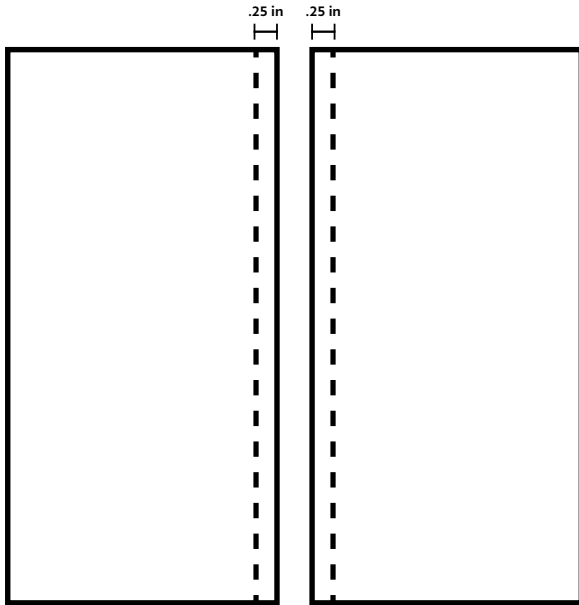

## TRIMMING

Product may be table trimmed or double-cut.

Trim .25 inches off of printing from each panel to achieve pattern match.

Use a very sharp, single-edge razor blade. Use a new razor blade for each cut.

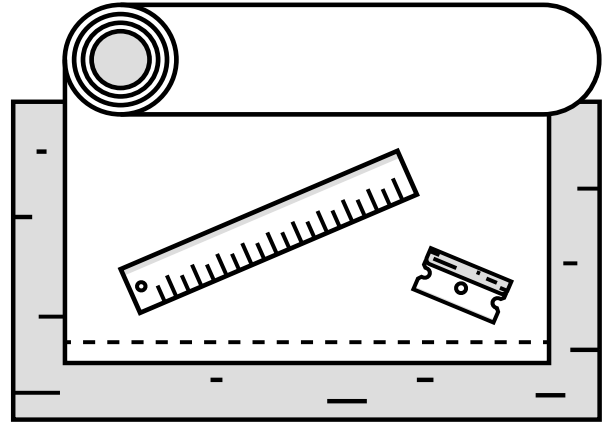

4



## PASTING

Use Maya Romanoff Clear Strippable Adhesive MR-RA-888 or comparable.

Pre-paste the wall and allow 2-3 minutes for paste to tack up before hanging.

Apply a generous, even coat of adhesive to backside of product and let relax.

Typical relaxing time is 5 minutes until adhesive tacks up. Perform a test on a small strip to determine appropriate relaxing time. Expect it to expand approximately  $3/16$  of an inch after paste is applied.

Allow the paste to soak into each sheet for the appropriate time before hanging in order to avoid bubbling, shrinking & seam opening.

Do not fold or crease the wallcovering.

Do not get paste on the face of the product. **If paste gets on the face of the product, do not scrub nor rub.** Instead, immediately gently wipe clean with a soft, damp cloth. Do not use paper towel on the product.



5

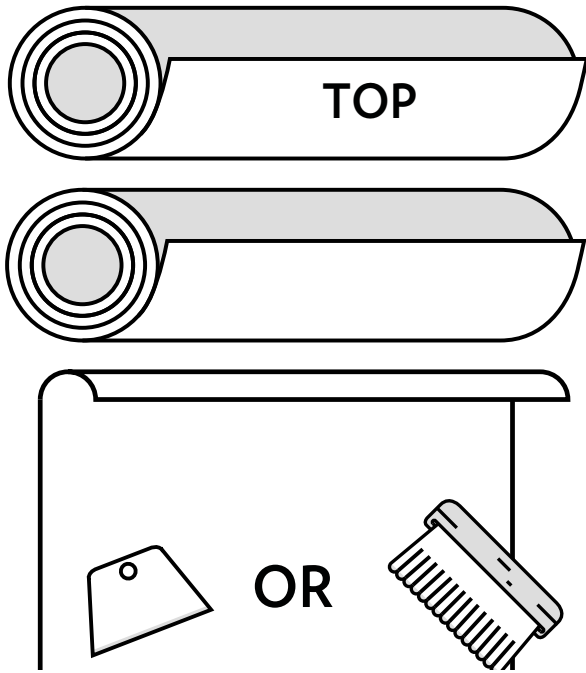

## HANGING

Rolls are marked “TOP.” We recommend pattern to be straight hung. **DO NOT** reverse hang.

Apply product to the wall using a soft-bristled nylon brush. **Do not use a stiff brush.**

Gently smooth product with brush to remove bubbles.

A seam roller may be used to set seams. Please take proper precaution.

Go back and ensure all bubbles are smoothed out before leaving. Any bubbles left upon completion of install will be permanent.

Use a corner seam roller to ease the material into moldings, casework, etc. prior to cutting the product.

Slight color and/or pattern match variation may occur.

6

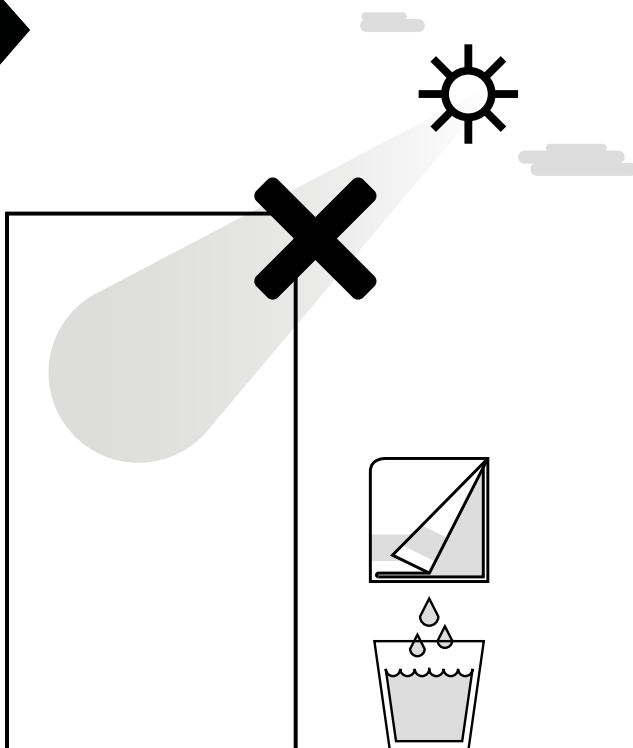

## CARE & CLEANING

Avoid direct or reflected sunlight. Our wallcoverings are not guaranteed against fading or color change.

Maya Romanoff wallcoverings are formulated for dry-use areas.

Before cleaning any wallcoverings, test first on a small, inconspicuous area.

Avoid getting the wallcovering excessively wet.

Never use abrasive cleansers or steel wool as they will mar the surface.

Clean by blotting the soiled area with a soft, clean cloth, dampened with a mild solution of clear liquid detergent. Dry with a soft, clean cloth.

Do not use harsh cleaners, solvents, or chemicals of any kind to clean Maya Romanoff products unless following the guidelines outlined in our Care, Cleaning and Disinfecting document, available at [MayaRomanoffDropbox.com](https://www.mayaromanoff.com/resources/care-cleaning-and-disinfecting). When used as directed, disinfectant wipes and diluted bleach/water solutions can be safe and effective sanitization methods for the majority of our wallcoverings.

# Serigraph Brocade™ (MR-SPB SERIES) TRIMMING INSTRUCTIONS



- Product may be table trimmed or double-cut.
- Trim .25 inches off of printing from each edge of panel to achieve pattern match.
- Use a very sharp, single-edge razor blade. Use a new razor blade for each cut.

